

VALVE / VALVOLA 5/2

SINGLE SOLENOID PILOT - INTERNAL PRESSURE RETURN
 COMANDO ELETTROPNEUMATICO - RIPOSIZIONAMENTO A MOLLA

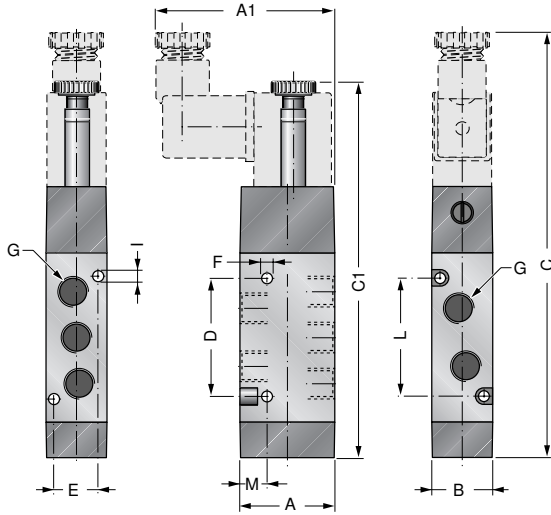

Size	A	A1	B	C	C1	D	E	ØF	G	ØI	L	M
1/8	28	~53	18	112	~125,5	35	13	3,2	G1/8	3,2	35	8
1/4	32	~55	22	142,5	~129	50	16,2	4,2	G1/4	3,5	50	7,3

K52W101.

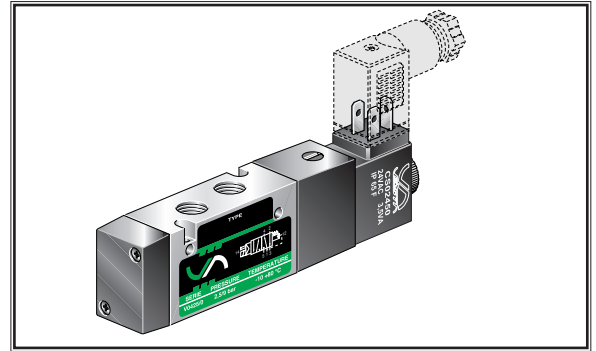

SIMBOLS / SIMBOLI

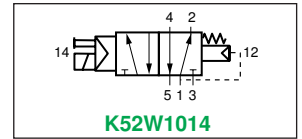
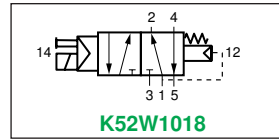

DIAGRAMS / DIAGRAMMI

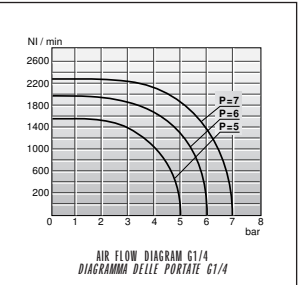
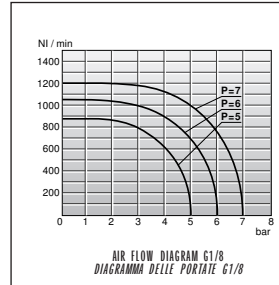

VALVE / VALVOLA 5/2

DOUBLE SOLENOID PILOT / DOPIO COMANDO ELETTROPNEUMATICO

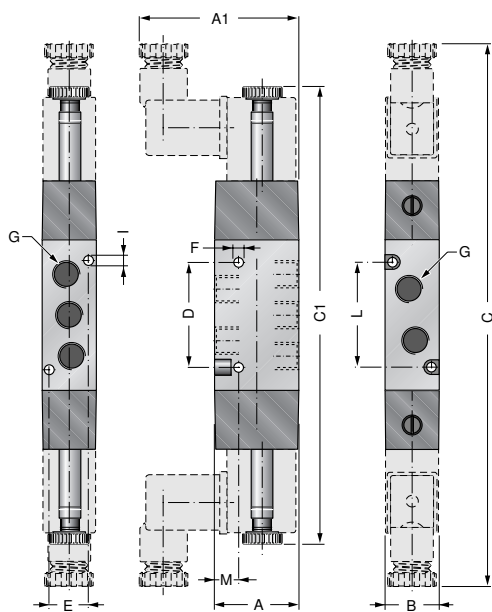

Size	A	A1	B	C	C1	D	E	ØF	G	ØI	L	M
1/8	28	~53	18	180	~152	35	13	3,2	G1/8	3,2	35	8
1/4	32	~55	22	202	~174	50	16,2	4,2	G1/4	3,5	50	7,3

K52W201.

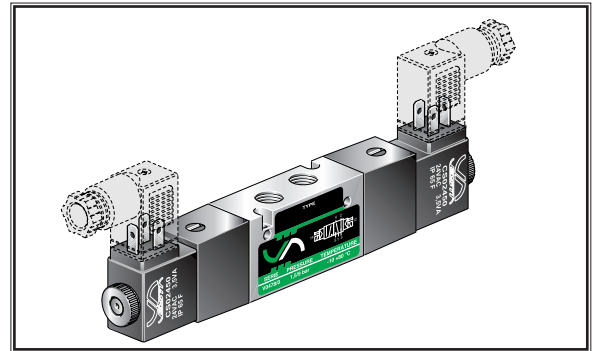

SIMBOLS / SIMBOLI

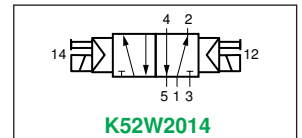
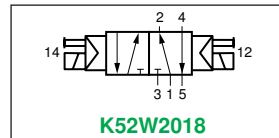

DIAGRAMS / DIAGRAMMI

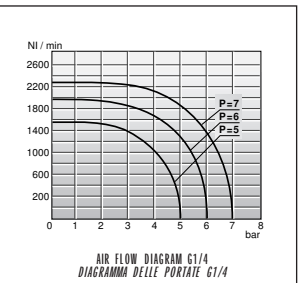
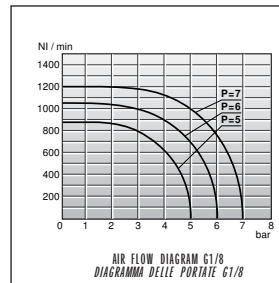

K52W10E.

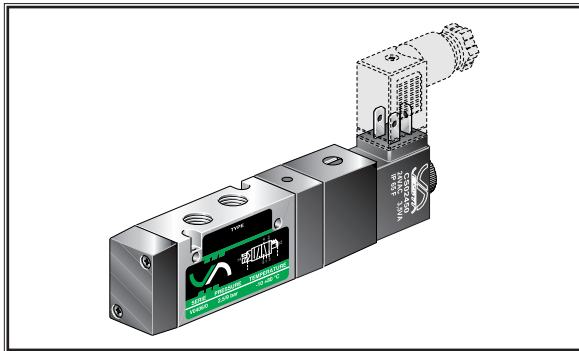

SIMBOLS / SIMBOLI

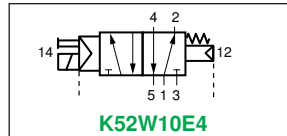
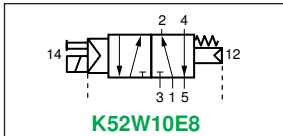

DIAGRAMS / DIAGRAMMI

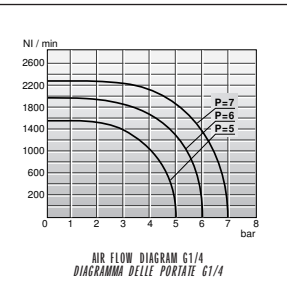
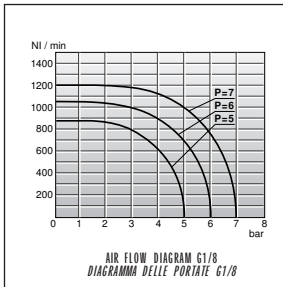

VALVE / VALVOLA 5/2

SINGLE SOLENOID PILOT - EXTERNAL PRESSURE RETURN
COMANDO ELETTROPNEUMATICO - PILOTAGGIO ESTERNO

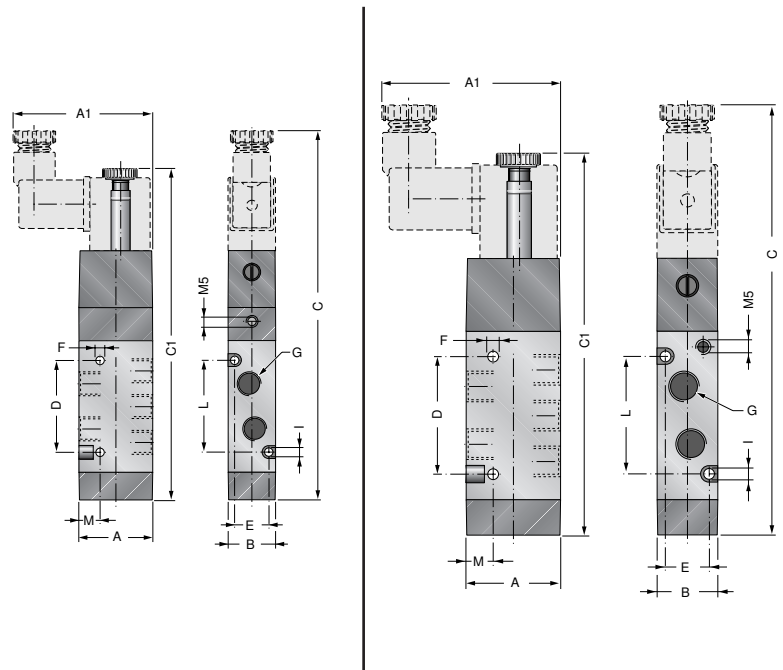

Size Taglia	A	B	C	D	E	ØF	G	ØI	L	M	A1	C1
1/8	28	18	112	35	13	3,2	G1/8	3,2	35	8	53	127
1/4	32	22	142,5	50	16,2	4,2	G1/4	3,5	50	7,3	55	129

K52W20E.

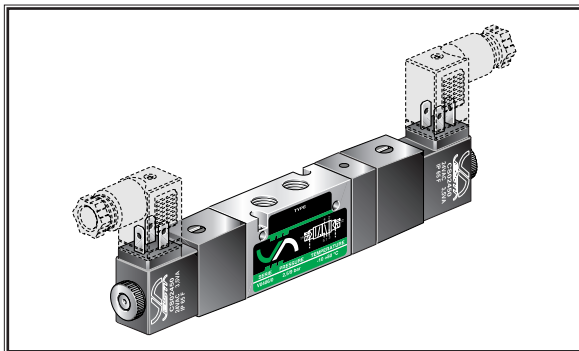

SIMBOLS / SIMBOLI

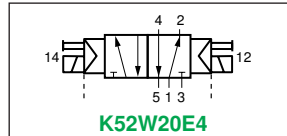
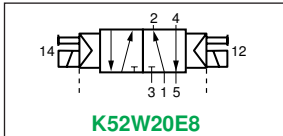

DIAGRAMS / DIAGRAMMI

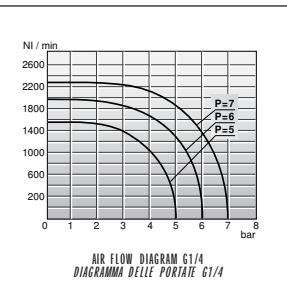
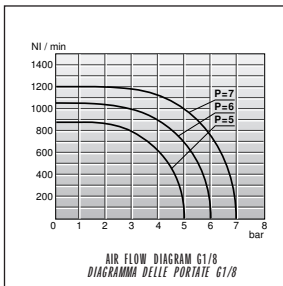

VALVE / VALVOLA 5/2

DOUBLE SOLENOID PILOT - EXTERNAL PRESSURE RETURN
DOPPIO COMANDO ELETTROPNEUMATICO - PILOTAGGIO ESTERNO

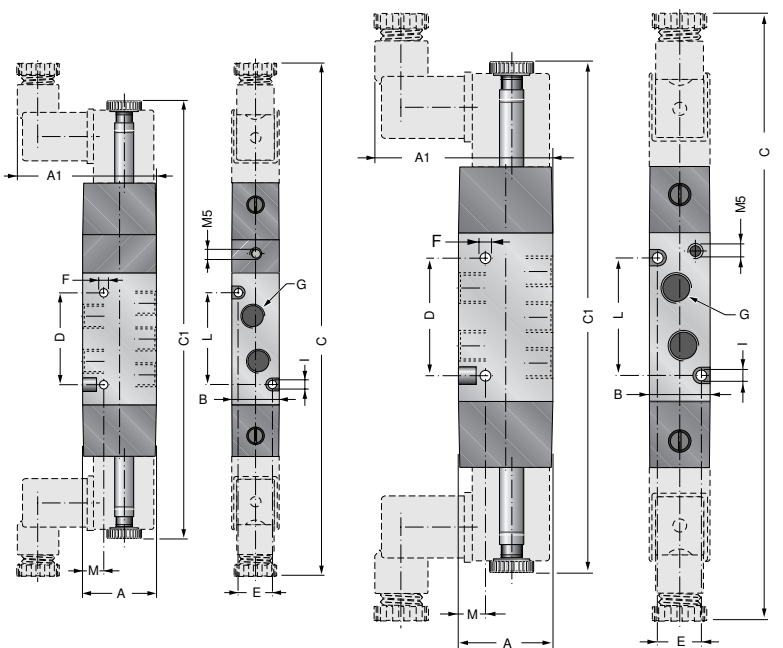

Size Taglia	A	B	C	D	E	ØF	G	ØI	L	M	A1	C1
1/8	28	18	180	35	13	3,2	G1/8	3,2	35	8	53	152
1/4	32	22	202	50	16,2	4,2	G1/4	3,5	50	7,3	55	174